



A  **x12** **B**  **x2** **C**  **x6**
10x30 mm 3,5x42 mm 4,5x45 mm

D  **x1** **E**  **x5** **F**  **x1**
GLUE 3,5x25 mm

G  **x2** **H**  **x6** **I**  **x4**

1.

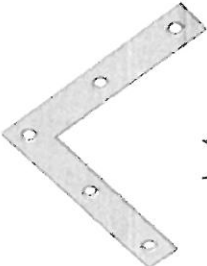
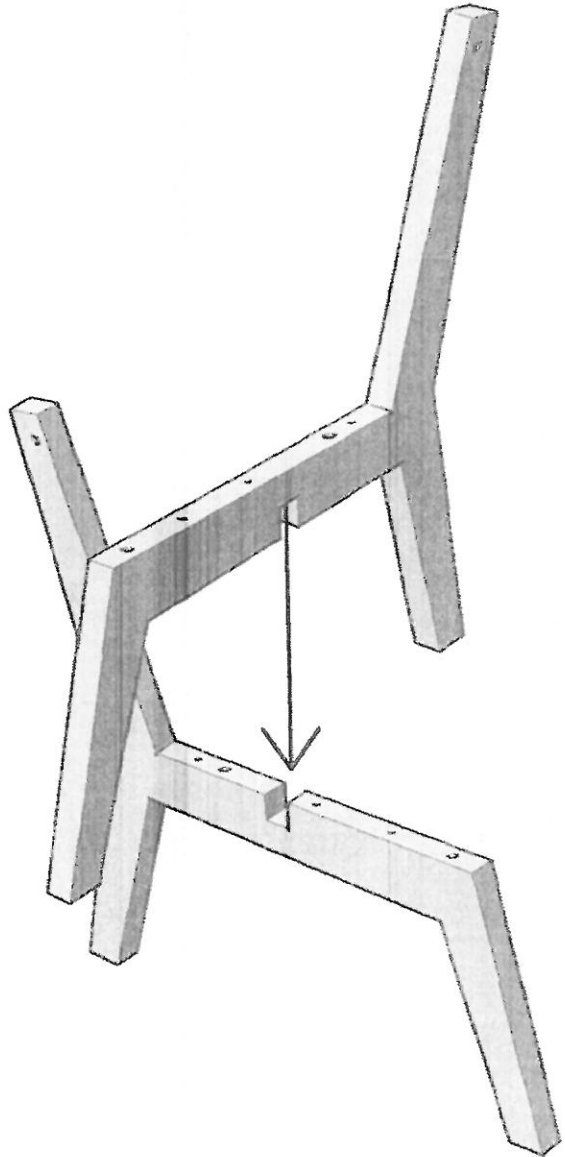

2.

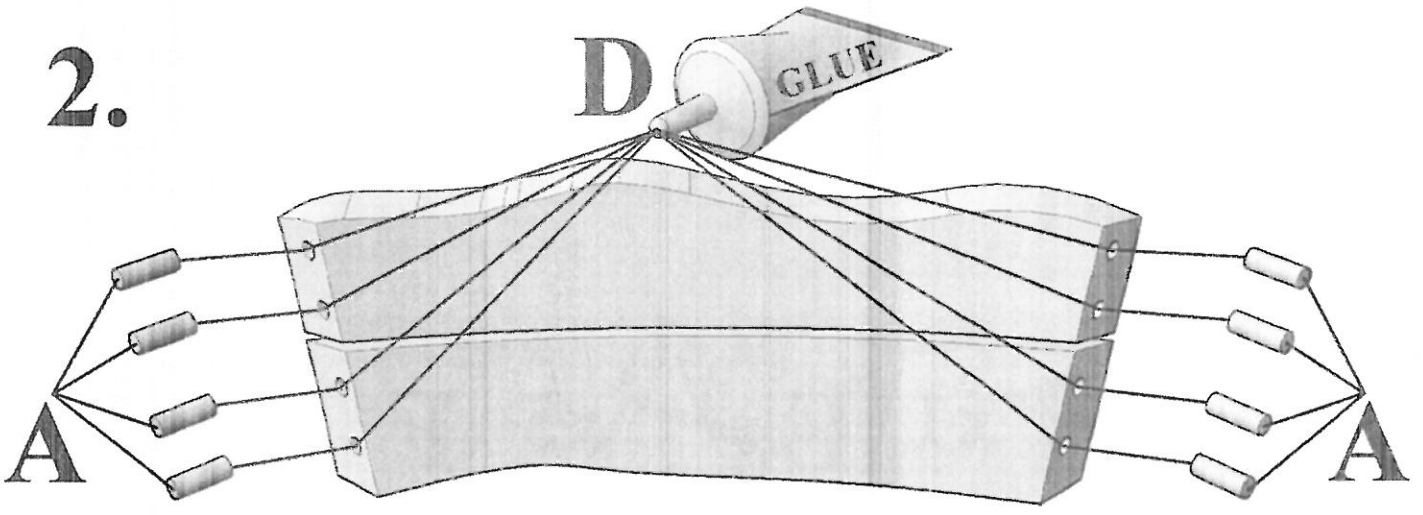

3.

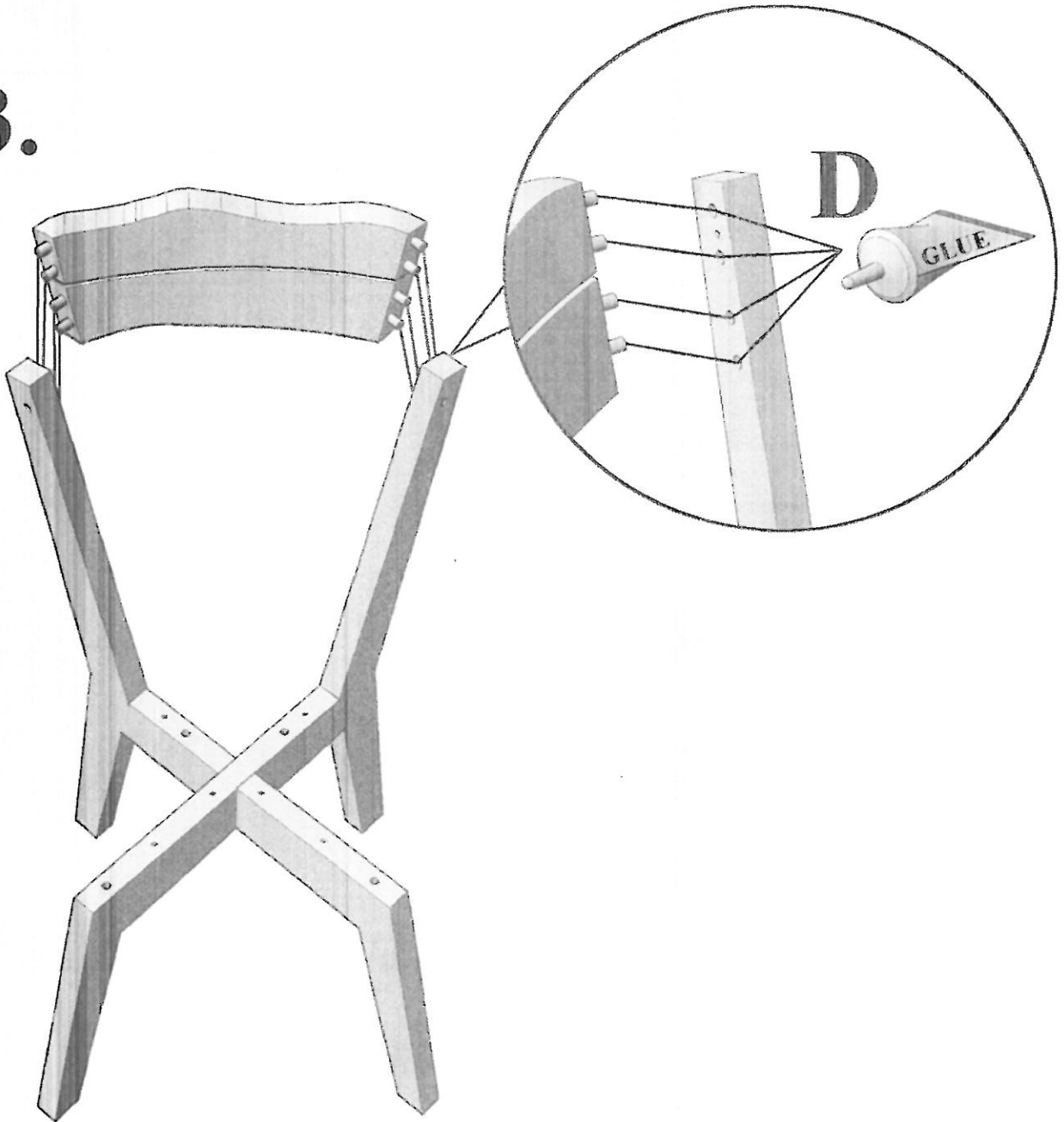

4.
B+G

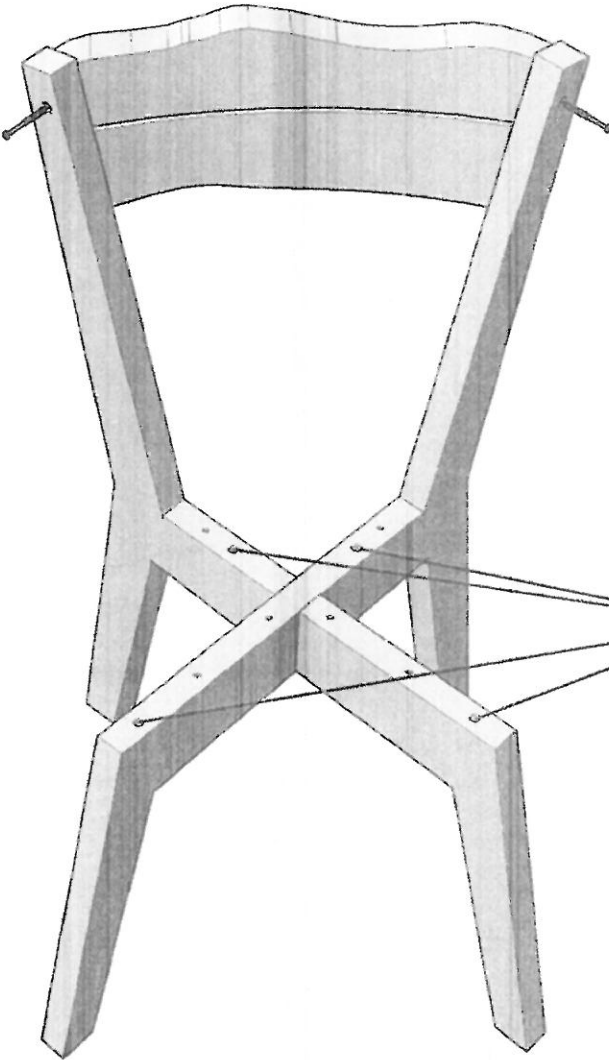
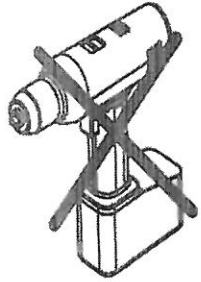

B+G

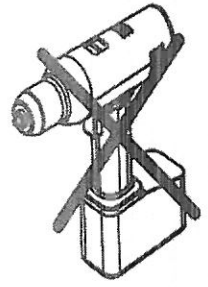

D



5.

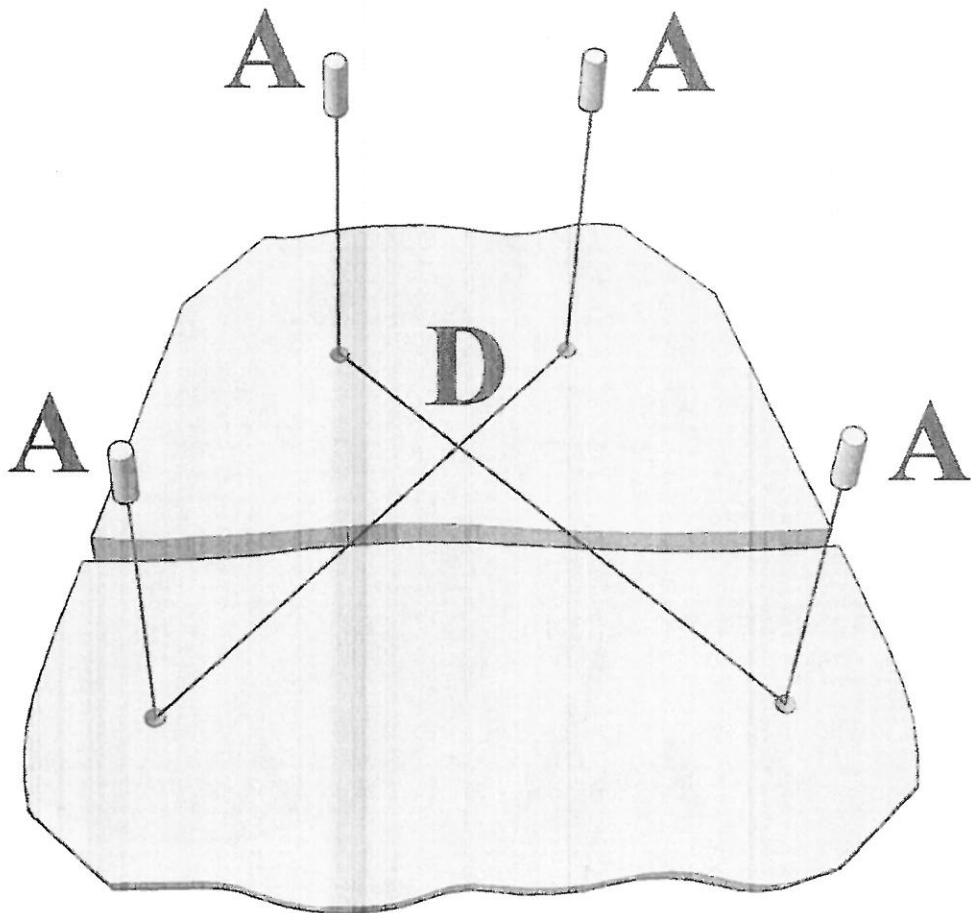

6.

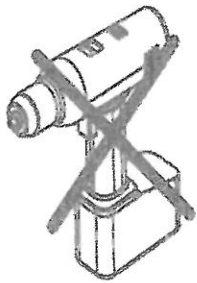
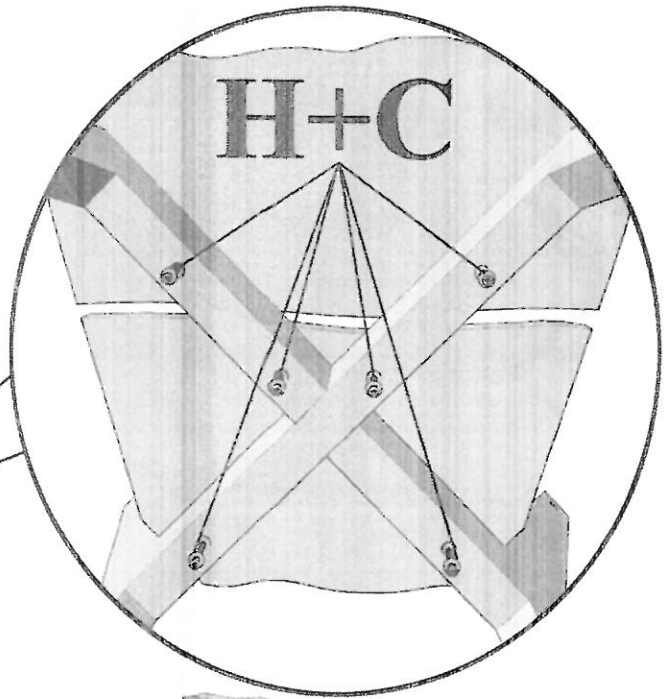
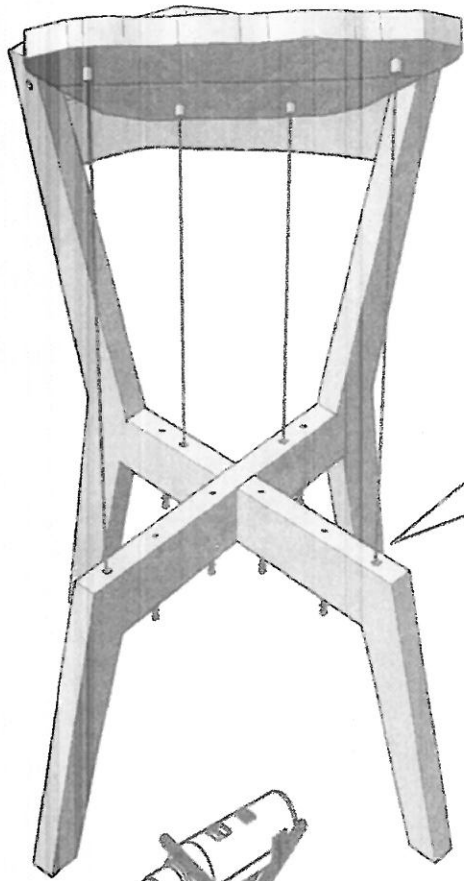

7.

