

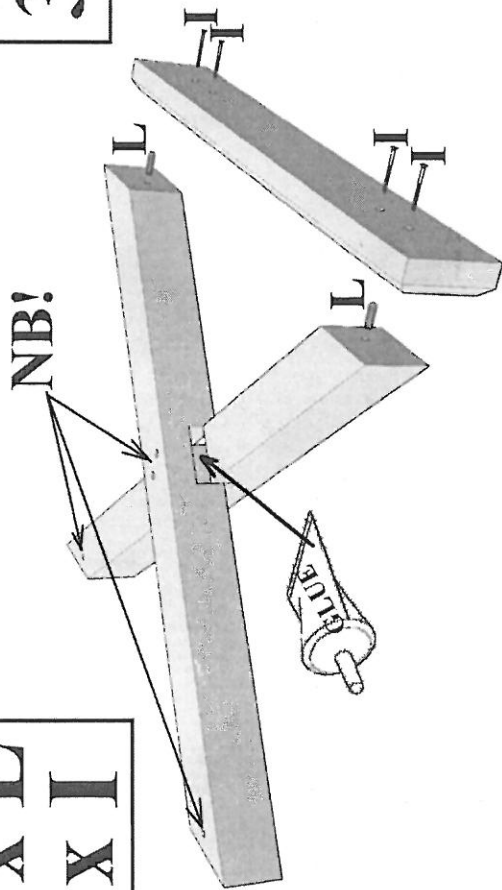

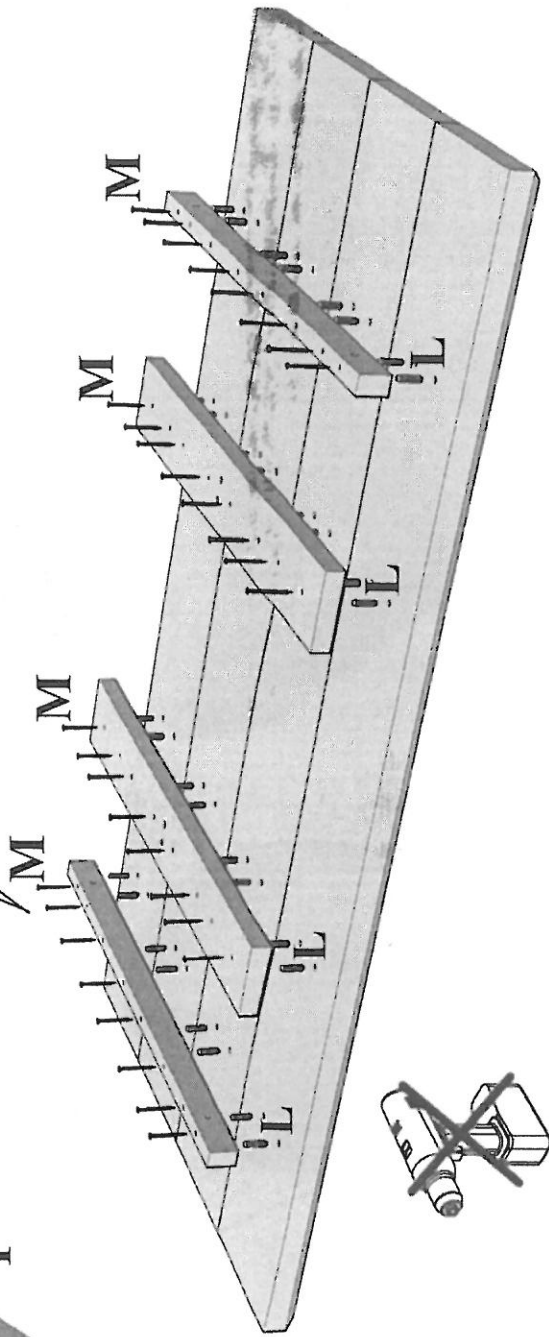

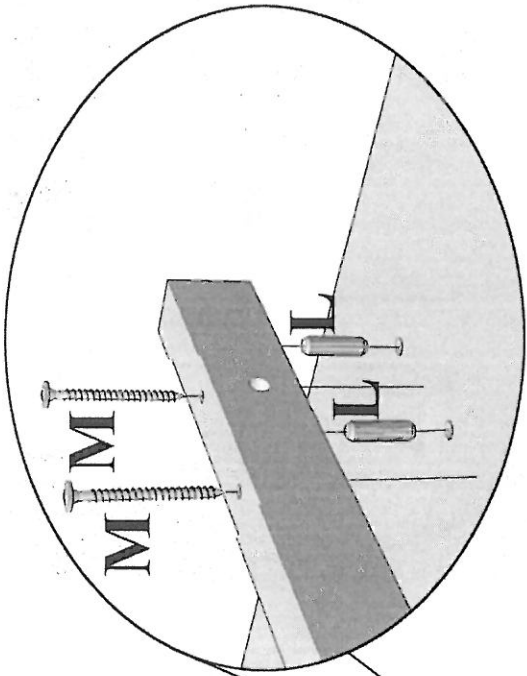





1.
4 x K
4 x L
8 x I



2.
32 x L
32 x M



I	 50 mm	x 8	C	 x 4
L	 30 mm	x 32	E	 x 4
M	 50 mm	x 32	F	 x 4
A	 40 mm	x 8	N	 No 35 mm x 16
B	 60 mm	x 8	D	 x 8

3.

4xA
4xB

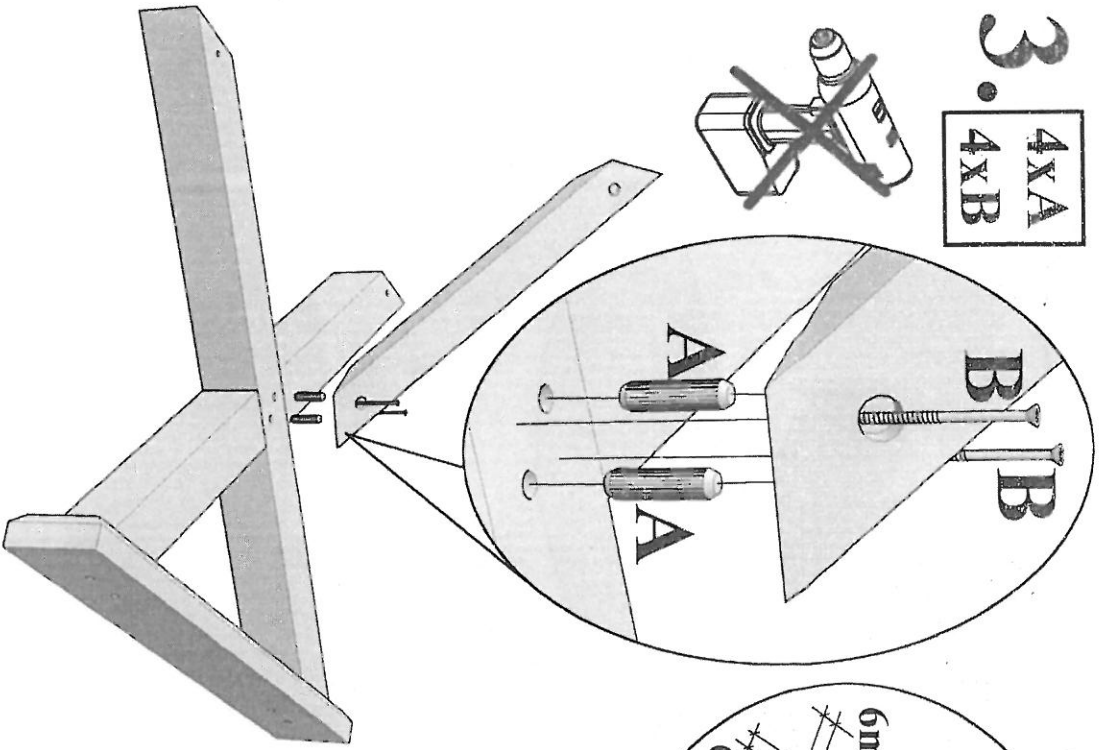
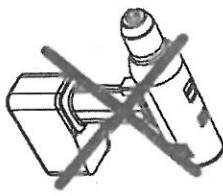

5.

16xN
8xD

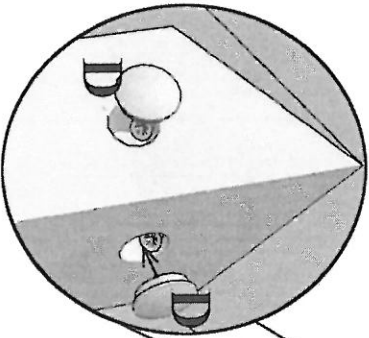
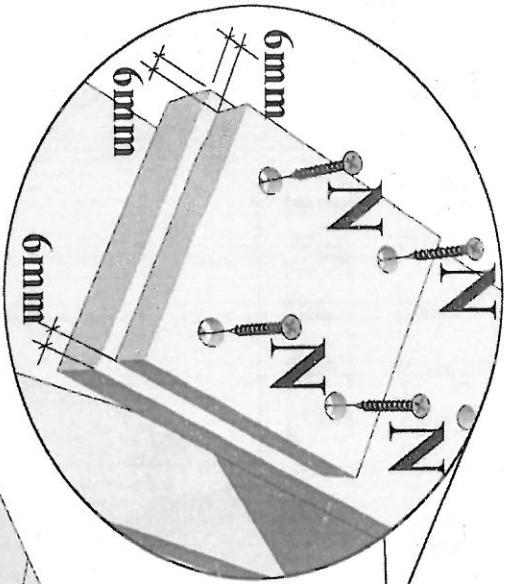

4.

4xA	4xE
4xB	4xF
4xC	

